

STATE OF TEXAS
CLASSIFICATION OF
MOTOR VEHICLE
TRAFFIC CRASHES IN TEXAS
2016 EDITION



TEXAS DEPARTMENT OF TRANSPORTATION
Traffic Operations Division – CDA
CR-102
6/1/2016
Version 1.3

This Page Intentionally Left Blank

Table of Contents

DOCUMENT INFORMATION, VERSION CONTROL	6
INTRODUCTION.....	7
1.0 DEFINITIONS.....	8
1.1 Trafficway.....	8
1.2 Roadway	8
1.3 Road	8
1.4 Shoulder.....	8
1.5 Work Zone	8
1.6 Motor Vehicle	9
1.7 Motorized Conveyance	9
1.8 Railroad Train	9
1.9 School Bus.....	9
1.10 Motorcycle.....	9
1.11 Pedalcycle.....	10
1.12 Pedestrian.....	10
1.13 Driver	10
1.14 Crash	10
1.15 Unstabilized Situation.....	10
1.16 Cataclysm	11
1.17 Harmful Event	11
1.18 Motor Vehicle Crash	11
1.19 Motor Vehicle Traffic Crash.....	11
1.20 In Transport.....	11
1.21 Transport Crash.....	12
1.22 Traffic Crash	12
1.23 On Roadway Crash.....	12
1.24 Off Roadway Crash.....	12
1.25 Non-traffic Crash.....	12
1.26 Fatal Crash	12

1.27 Non-fatal Injury Crash	13
1.28 Non-injury Crash	13
1.29 Person.....	13
1.30 Property	13
2.0 INTERPRETATIONS AND EXAMPLES.....	14
2.1 Trafficway.....	14
2.2 Motor Vehicle	14
2.2.1 Registration.....	15
2.2.2 Examples of Use.....	15
2.2.3 Driverless Motor Vehicle	15
2.2.4 Insufficient Information.....	16
2.2.5 Mechanical Failure.....	16
2.3 Crash After Stabilized Situations.....	16
2.4 Chain Reaction Crashes	17
2.5 Originating on a Trafficway	17
2.6 Terminating on a Trafficway.....	17
2.7 Crossing a Trafficway	18
3.0 CLASSIFICATION OF MOTOR VEHICLE TRAFFIC CRASH INJURIES	19
4.0 DEFINITIONS AND INTERPRETATIONS FOR CLASSIFICATION OF MOTOR VEHICLE TRAFFIC CRASH INJURIES.....	20
4.1 Injury	20
4.2 Fatal Injury	20
4.3 Incapacitating Injury	20
4.4 Non-incapacitating Evident Injury.....	20
4.5 Possible Injury.....	21
4.6 No Injury.....	21
4.7 Medical Examination	21
4.8 Time of Classification	21
4.9 Classification of Fatal Injuries	21
4.10 Discharge from Hospital.....	22
5.0 CLASSIFICATION BY LOCATION OF MOTOR VEHICLE TRAFFIC CRASHES ...	23

6.0 DEFINITIONS AND INTERPRETATIONS FOR LOCATION OF MOTOR VEHICLE TRAFFIC CRASHES.....	24
6.1 Classification by Relationship to Junction	24
6.2 Driveway Access.....	24
6.3 At Intersection Crash	24
6.4 Intersection Related Crash.....	24
6.5 Driveway Access Crash	24
6.6 Non-intersection Crash	25
6.7 Class of Trafficway.....	25
6.8 Land Use Character	25
6.9 Highway Engineering Terms	25
6.10 Assignment by Class of Trafficway	26
6.11 Assignment by Political Subdivision	27
6.12 Jurisdiction	27
6.13 Place of Injury or Damage.....	27
6.14 Boundary Lines	28
6.15 Diagram of the Trafficway*	29
6.16 Diagram of an Intersection*.....	30
6.17 Diagram of an Interchange*	31
7.0 CLASSIFICATION BY TYPE OF MOTOR VEHICLE TRAFFIC CRASHES.....	32
8.0 DEFINITIONS AND INTERPRETATIONS OF TYPE OF MOTOR VEHICLE TRAFFIC CRASHES.....	33
8.1 Motor Vehicle Crash	33
8.2 Non-collision Crash.....	33
8.3 Collision Crash.....	34
8.4 Interpretations	38
8.5 Diagrams of Non-Collision Events, On or Off Roadway	39
8.6 Diagrams of Collision Events, On or Off Roadway.....	42
8.7 Diagrams of When More Than One Event Occurs.....	44
9.0 CLASSIFICATION OF MOTOR VEHICLE NON-TRAFFIC CRASHES.....	47
IF YOU HAVE ANY QUESTIONS OR NEED FURTHER CLARIFICATION.....	48

DOCUMENT INFORMATION, VERSION CONTROL

Date	Version	Author(s)	Section(s)	Update(s)
3/26/2015	1.2	R. Holt	All	Add Table of Contents, add Version Control page, and revise Contact Information, formatting. Update reference to Vital Statistics Instructions for Classifying Underlying Cause of Death, 2014.
5/27/2016	1.3	R. Holt	1.6, 1.7 1.15	Correct definitions of Motor Vehicle and Motorized Conveyance Add definition

INTRODUCTION

Texas Department of Transportation (TxDOT) has developed this manual, Classification of Motor Vehicle Traffic Crashes in Texas, in accordance with Texas Transportation Code and Administrative Rule(s). TxDOT has referenced the American National Standards Institute (ANSI) D16.1 Standard, 2007 Manual on Classification of Motor Vehicle Traffic Accidents, 7th edition as the primary source for definitions, classifications of crashes and related diagrams.

The assignment of crashes to a geographical location, such as a city or county, indicates only that the crashes occurred within the geographical limits of the jurisdiction. These assignments do not imply that the jurisdiction is responsible for identified crashes or that it could have prevented them.

This manual is a tool to guide peace officers in classification standards for motor vehicle traffic crashes. Nothing in this manual is to be construed as a requirement for crash reporting or investigation. Peace officers should always consult the CR-100 for specific instructions on completing the CR-3 crash report.

Prepared and Distributed by:

Texas Department of Transportation
Traffic Operations Division - CDA
PO Box 149349
Austin, TX 78714-9349

1.0 DEFINITIONS

1.1 Trafficway

Any land way open to the public as a matter of right or custom for moving persons or property from one place to another.

1.2 Roadway

That portion of a trafficway designed, improved, and ordinarily used for motor vehicle travel or, where various classes of motor vehicles are segregated, that part of a trafficway used by a particular class. Separate roadways may be provided for northbound and southbound traffic (as well as eastbound and westbound) or for trucks and automobiles. Bridle paths, bicycle paths, and shoulders are not included in this definition. In the event a highway includes two or more separate roadways, the term “roadway” as used herein shall refer to any such roadway separately but not to all such roadways collectively.

1.3 Road

That part of a trafficway which includes both the roadway and any shoulder alongside the roadway. Includes designated parking areas on a roadway or between the roadway and curb.

1.4 Shoulder

That part of a trafficway contiguous with the roadway for emergency use, for accommodation of stopped vehicles, and for lateral support of the roadway structure. The line between the roadway and the shoulder may be a painted edge line, a change in surface color or material, or a curb. On some modern trafficways, there may be a surfaced shoulder on the right side, and frequently a narrower shoulder on the left side of a one-way roadway.

1.5 Work Zone

Work Zone is an area of a trafficway where construction, maintenance, or utility work activities occur. Signs, channelizing devices, barriers, pavement markings, and/or work vehicles typically mark a work zone. It extends from the first warning sign or flashing lights on a vehicle to the END ROAD WORK sign or the last traffic control device. A

work zone may exist for short or long durations and may include stationary or moving activities.

1.6 Motor Vehicle

Motor Vehicle is a motorized (mechanically or electrically powered) road vehicle, including its cargo (for crash reporting purposes only), not operated on rails. This includes but is not limited to the following: all-terrain vehicle, bus, farm tractor, golf cart, moped, motorcycle, motor-driven cycle, multi-function school activity bus, passenger car, recreational off highway vehicle, road tractor, school bus, truck, truck tractor. Texas Transportation Code: Sections 521.001 (6, 7, 8, 9), 541.201 (3, 4, 8, 9, 10, 11-a, 12, 14, 16, 21, 22, 24,), 502.001 (17, 19-a) and 642.001 (4).

1.7 Motorized Conveyance

Motorized Conveyance is a smaller motorized vehicle including but not limited to pocket bikes, go-carts, riding lawn mowers, Segways, motor assisted scooters

1.8 Railroad Train

Railroad Train is a steam engine, electric or other motor, with or without cars coupled thereto, operated upon rails, except streetcars. For purposes of this manual, motor vehicles equipped with flanged wheels and driven upon the tracks will be considered a railway vehicle. Non-motorized devices not set in motion by a railroad train or railway vehicle are not considered a railroad train or railway vehicle.

1.9 School Bus

School Bus is a motor vehicle that was manufactured in compliance with Federal motor safety vehicle standards for school buses in effect on the date of manufacture and that is used to transport pre-primary, primary, or secondary students on a route to or from school or on a school-related activity trip other than on routes to and from school. The term does not include a school-chartered bus or a bus operated by a mass transit authority.

1.10 Motorcycle

Motorcycle is a two-wheeled or three-wheeled motor vehicle designed to transport one or two people. Included are motor scooters, mini-bikes, and mopeds. Included is every motor vehicle having a saddle for the use of the rider and designed to travel on not more than three (3) wheels in contact with the ground but excluding a tractor or motor-

assisted bicycle. "Motor-assisted bicycle" means a bicycle which may be propelled by human power or a motor, or both, with a motor of a capacity of less than sixty (60) cubic centimeters piston displacement, which is capable of a maximum speed of not more than twenty (20) miles per hour on a flat surface with not more than a one (1) percent grade in any direction when the motor is engaged. For purposes of this manual, motor scooters, motorbikes, minibikes, and motor- assisted bicycles (moped) when the motor is being used to propel it, will be considered as motor vehicles under the appropriate style classification.

1.11 Pedalcycle

Pedalcycle is a non-motorized vehicle propelled by pedaling.

- Includes: Bicycle (any size, with two wheels in tandem), tricycle, unicycle, sidecar or trailer attached to any of the above devices, and pedal car (three-wheeled PPV).
- Excludes these devices when towed by a motor vehicle, including hitching.

1.12 Pedestrian

Pedestrian is a person who is not an occupant of a motor vehicle in transport.

- Includes: Person afoot, sitting, lying, or working upon a way or place, a person in or operating a pedestrian conveyance (non-motorized wheelchair or motorized mobility device), a person who is adjacent to the motor vehicle regardless of their actions.
- Excludes: Person boarding or alighting from another conveyance, except pedestrian conveyance. Person jumping or falling from a motor vehicle in transport.

1.13 Driver

Driver is an occupant who is in actual physical control of a motor vehicle or, for an out-of-control motor vehicle, an occupant who was in control until control was lost.

1.14 Crash

Crash is an identified event that produces injury, death, or damage. Highway safety activists have been working to replace the term "accident" with "crash," which more accurately reflects the potential and actual seriousness of incidents. The term "crash" is used throughout this document instead of "accident" with reference to serious vehicular incidents.

1.15 Unstabilized Situation

Unstabilized Situation is a set of events not under human control. It originates when control is lost and terminates when control is regained or, in the absence of persons who are able to regain control, when all persons and property are at rest. Unstabilized situation excludes:

- Deliberate intent – Suicide, homicide, and other harmful events under human control do not imply the existence of an unstabilized situation. A set of unintended consequences of such acts might be an unstabilized situation.
- Legal Intervention – Legal intervention is a type of deliberate intent involving intentional acts by a law-enforcement agent or other official. Examples:
 - If a law-enforcement agent or official vehicle intentionally drives into a pursued driver, the crash is classified as legal intervention.
 - If a pursued driver intentionally or unintentionally crashes into a road block set up by law enforcement to stop them, this is classified as legal intervention.
 - If a driver is being pursued by a law-enforcement unit, then loses control of their vehicle and crashes, this crash is not considered to result from legal intervention unless the police intended for the lawbreaker to crash.

1.16 Cataclysm

Cataclysm is an avalanche, cloudburst, downburst, cyclone, earthquake, flood, hurricane, landslide, mudslide, lightning, tidal wave, torrential rain, tornado, or volcanic eruption.

1.17 Harmful Event

Harmful Event is an occurrence of injury or damage.

1.18 Motor Vehicle Crash

Motor Vehicle Crash is a crash involving a motor vehicle in transport, does not involve an aircraft or watercraft, and does not include any harmful event involving a railway train in transport prior to involvement of a motor vehicle in transport.

1.19 Motor Vehicle Traffic Crash

Motor Vehicle Traffic Crash is any motor vehicle crash that occurs on a trafficway or that occurs after the motor vehicle runs off roadway but before events are stabilized.

1.20 In Transport

Transport denotes the state or condition of a motor vehicle, which is in motion or within the portion of a transport way ordinarily used for travel by similar vehicles. When applied to motor vehicles, in transport means on a roadway or in motion within or outside the trafficway.

1.21 Transport Crash

Transport Crash has all of the following characteristics:

- Involves a vehicle in transport.
- The first harmful event is not produced by the discharge of a firearm or explosive device.
- Does not directly result from a cataclysm where the timing is such that the cataclysm is occurring at the time of the crash.

1.22 Traffic Crash

Traffic Crash is a vehicle crash in which either:

- The unstabilized situation originates on a trafficway, or
- A harmful event occurs on a trafficway.

1.23 On Roadway Crash

On Roadway Crash is either:

- A collision crash in which the initial point of contact between colliding units in the first harmful event is within a roadway, or
- A non-collision crash in which the vehicle involved was partly or entirely on the roadway at the time of the first harmful event.

1.24 Off Roadway Crash

Off Roadway Crash is any vehicle crash other than an on roadway crash.

1.25 Non-traffic Crash

Non-traffic Crash is a vehicle crash that is not a traffic crash.

1.26 Fatal Crash

Fatal Crash is any injury crash that results in one or more fatal injuries.

1.27 Non-fatal Injury Crash

Non-fatal Injury Crash is any injury crash other than a fatal crash.

1.28 Non-injury Crash

Non-injury Crash is any vehicle crash other than an injury crash. A non-injury crash is also called property damage only crash.

1.29 Person

Person is any living human, firm, co-partnership, association, or corporation. Within the context of this manual, a fetus is not considered to be a person.

1.30 Property

Property is any physical object other than a person.

- Includes: Real property, personal property, animals (wild or domestic), signs, guardrails, impact attenuators, trees, fences, traffic control devices, shrubs.

2.0 INTERPRETATIONS AND EXAMPLES

2.1 Trafficway

The following interpretations and examples further clarify the definition in 1.1 Trafficway for determining trafficway status on any way or place.

- **Excludes:** Exclusions from trafficway status apply only if the land ways or places are not open to the public for purposes of vehicular travel as a matter of right or custom, such as a trafficway closed for repair purposes. Private ownership is not the sole criterion for the exclusion. For example, the approach to a private fishing dock or boat-launching dock is a trafficway if it is open to the public for vehicular travel; that is, any person may drive a motor vehicle upon the dock approach. Also, the fact that a fee or toll may be charged for the use of the trafficway does not remove it from trafficway status.
- **Examples:** Trafficway includes approaches to public buildings, docks, and stations, but excludes private driveways, parking stalls and parking aisles of public parking lots, places away from trafficways, ramps, or roads on airfields, farms, industrial premises, mines, quarries, and private grounds.
- **Jurisdiction:** Maintenance or police jurisdiction is not a criterion for deciding trafficway status of any way or place.
- **Boundary Lines:** Boundary lines are the lateral limits of the trafficway. In the case of public right-of-way, they are usually coincident with the property lines, which mark the line between the trafficway and the adjoining property. In the case of right-of-way on private property, the boundary lines are the lateral limits of the easement or other area set aside as a trafficway.

2.2 Motor Vehicle

The following interpretations and examples further clarify the definition in 1.6 for determining motor vehicle status of any device.

- **Excludes:** Excluded from motor vehicle status are devices used solely to move persons or property within the confines of a building and its premises, such as an electric baggage or mail truck used solely within a railway station, or a forklift used solely within an industrial plant. The exclusion does not apply if these devices are in transport upon a way or place outside the confines of a building and its premises for the purpose of transporting persons, property or the device itself from one place to another.

2.2.1 Registration

Whether a particular device is considered to be a motor vehicle shall not depend upon registration requirements.

2.2.2 Examples of Use

The use of the device at the time of the crash is the primary criterion for establishing motor vehicle status. Any determination regarding under own power, or in use on a way or place, is not difficult. Also, establishing motor vehicle status is not a problem with devices that come within the provisions of motor vehicle registration laws. Problems arise with devices normally not used in transport upon trafficways, and with motor vehicles used in an uncommon manner.

The following examples are illustrative of the application of the use concept in determining motor vehicle status of the device or motor vehicle at the time of the crash:

- A team of horses is drawing a registered motor vehicle upon a city street: It is other road vehicle (animal harnessed to a conveyance).
- A registered motor vehicle is being used to draw a breaking plow engaged in breaking ground on a farm: It is machinery (farm) while engaged in plowing.
- A registered truck hauling concrete (transit-mix) is engaged in discharging or spreading its load of concrete at a road construction site: It is machinery (road construction in work zone) while engaged in discharging or spreading its load of concrete.
- A motorized highway grader, under its own power, is moving from one work place to another, upon a public way: It is a motor vehicle in transport.
- A road roller, under its own power, is engaged in compacting road materials on a trafficway under construction: It is machinery (road construction in work zone) while engaged in compacting road materials or otherwise moving at the construction site.
- A registered truck, with a blade attached for plowing snow, is engaged in plowing snow from a trafficway: It is machinery (road maintenance) while engaged in plowing snow.
- A riding motorized lawn mower, under its own power, is being driven from one home to another, upon a trafficway: It is a motor vehicle in transport.

2.2.3 Driverless Motor Vehicle

A driverless motor vehicle, though previously parked, or a motor vehicle out of control while being towed or pushed, is considered to be a motor vehicle in transport. Also, a driverless motor vehicle, or an abandoned motor vehicle, upon a roadway, is considered

to be a motor vehicle in transport. This principle does not apply to such devices as farm or industrial machinery, highway graders, construction machinery, or similar devices, which are not in use for transport at the time of the crash.

2.2.4 Insufficient Information

When available information is insufficient to determine whether the injury or damage resulted from a motor vehicle in a transport crash, assume that it did and that the event is a motor vehicle crash.

2.2.5 Mechanical Failure

Any mechanical failure, such as a tire blowout, broken fan belt, broken axle, or similar event, does not, by itself, constitute a motor vehicle crash. However, any subsequent injury or damage-producing event resulting from the mechanical failure would be a motor vehicle crash if the motor vehicle was in transport.

2.3 Crash After Stabilized Situations

A stabilized situation marks the end of an event; that is, nothing further will occur insofar as the event itself is concerned, but other events may follow because of subsequent actions closely related to the first event. The stabilized situation may be brief, but it separates the end of one event from the beginning of another event caused by further action. In some events, a temporary position of safety may be reached; that is, a position in which a person would not be in jeopardy again if the position was maintained until rescue or the hazards were removed. In a crash in which a stabilized situation can be identified, subsequent injury or damage-producing events should not be considered a part of the original crash.

The following examples illustrate the application of the stabilized situation principle:

- In a motor vehicle crash, live electric wires fall on a motor vehicle, but there is no injury from the electric current because the occupants remain in the motor vehicle. This is a stabilized situation. Any subsequent injury resulting from attempts to leave the motor vehicle, or attempts to rescue, attributable to the electric current, is not a part of the original motor vehicle crash.

- In a motor vehicle crash, the occupants of the motor vehicle are carried or thrown into water, but there is no injury from the submersion, and the occupants reach a temporary position of safety, other than the motor vehicle itself, unless it has stabilized and is no longer sinking. This is a stabilized situation. Any subsequent injury from attempts to reach shore, or attempts to rescue, attributable to submersion, is not a part of the original motor vehicle crash.
- In a motor vehicle crash, objects are loosened which remain in place until all occupants are removed from the hazard of the objects that might fall or roll. This is a stabilized situation. Any subsequent injury or damage, attributable to the fall or roll of the loosened objects, is not a part of the original motor vehicle crash.
- In a motor vehicle crash, the motor vehicle catches on fire and is burning, but all occupants have been rescued and the danger of the fire spreading is under control. This is a stabilized situation. However, if the heat of the fire induces ignition in nearby combustible materials, any subsequent injury or damage from the induced ignition is not a part of the original motor vehicle crash.
- In a motor vehicle crash, an involved motor vehicle carrying explosive materials is stopped and occupants and bystanders are removed from the scene. This is a stabilized situation. If the explosive materials subsequently detonate during attempts to remove or salvage, any injury or damage resulting from the explosion is not a part of the original motor vehicle crash.

2.4 Chain Reaction Crashes

Sometimes, in the same area and within a short time, several motor vehicles may be involved in crashes during an adverse driving condition, such as reduced visibility due to fog. In such chain reaction crashes, it is frequently difficult to determine afterward whether this event was one crash without a moment in which the crash situation was stabilized, or whether several crashes occurred with the crash situation stabilized between separate crashes. Consequently, for purposes of uniformity, consider such chain reaction crashes to be single motor vehicle crashes, unless a stabilized situation can be established between the several events that may occur in such chain reaction crashes.

2.5 Originating on a Trafficway

A motor vehicle crash that results from an unstabilized set of events originating upon any part of a trafficway shall be classified as a motor vehicle traffic crash.

2.6 Terminating on a Trafficway

If an unstabilized set of events originates off a trafficway, but the motor vehicle crash occurs on a trafficway, the crash is a motor vehicle traffic crash.

2.7 Crossing a Trafficway

If an unstabilized set of events originates and terminates off a trafficway, but during the series of events that motor vehicle crosses the traffic-way without incident, any crash that occurs off the trafficway in this case is a motor vehicle crash, but not a motor vehicle traffic crash.

3.0 CLASSIFICATION OF MOTOR VEHICLE TRAFFIC CRASH INJURIES

The injury classification for motor vehicle traffic crashes applies to any person involved in such crashes while either in or out of a motor vehicle. This classification is commonly used to describe the severity of motor vehicle traffic crashes in terms of the degree of injuries sustained. For this purpose, the entire crash is categorized according to the most serious injury sustained by any person involved. For example, if any person is killed in the crash, the crash is classified as a fatal injury crash, or simply as a fatal crash. If no person is injured, the crash is classified as a non-injury crash.

The categories are so defined that for the most part, neither medical examination nor special tests are required ordinarily for classification. Classification usually can be done by ordinary observation at the time of the crash or from information submitted on the crash report form.

The classification of injuries provides a category for any person involved in a motor vehicle traffic crash. There are five mutually exclusive categories of injury to persons by which such injury may be classified:

- Fatal injury
- Incapacitating injury
- Non-incapacitating evident injury
- Possible injury
- No injury

These classifications apply to injuries; however, they are also used to describe the severity of motor vehicle traffic crashes.

4.0 DEFINITIONS AND INTERPRETATIONS FOR CLASSIFICATION OF MOTOR VEHICLE TRAFFIC CRASH INJURIES

4.1 Injury

Injury is bodily harm to a person.

- Excludes: Effects of diseases, such as cerebral hemorrhage, stroke, heart attack, diabetic coma, and epileptic seizure.

4.2 Fatal Injury

Fatal Injury is any injury that results in death within thirty (30) days of the motor vehicle traffic crash.

4.3 Incapacitating Injury

Incapacitating Injury is any injury, other than a fatal injury, which prevents the injured person from walking, driving or normally continuing the activities the person was capable of performing before the injury occurred.

- Includes: Severe lacerations, broken or distorted limbs, skull or chest injuries, abdominal injuries, unconscious at or when taken from the crash scene, unable to leave crash scene without assistance.
- Excludes: Momentary unconsciousness.

4.4 Non-incapacitating Evident Injury

Non-incapacitating Evident Injury is any injury, other than a fatal injury or an incapacitating injury, which is evident to observers at the scene of the crash in which the injury occurred.

- Includes: Lump on head, abrasions, bruises, and minor lacerations.
- Excludes: Limping (the injury cannot be seen).
- Example: Pedestrian is unconscious on the ground after crash; his clothes are torn and blood oozes from abrasions; when the ambulance arrives, he is conscious, able to give information, and walks around. He goes to the hospital in the ambulance, but is able to sit up in it. There is no evidence that he is incapacitated.

4.5 Possible Injury

Possible Injury is any injury reported or claimed which is not a fatal injury, incapacitating injury or non-incapacitating evident injury. Possible injuries are those which are claimed or reported, or indicated by behavior, but not by wounds.

- Includes: Momentary unconsciousness, claim of injuries not evident, limping, complaint of pain, nausea, hysteria.
- Example: Occupant complains of pain but shows no signs of bleeding or other wound; leaves the scene in a taxi to keep an appointment. This is possible injury when classified at the time of leaving the scene.

4.6 No Injury

No Injury is a situation in which there is no reason to believe that the person received any bodily harm from the motor vehicle traffic crash in which they were involved.

- Includes: Confusion, excitement, anger, internal injuries unknown to the injured until after leaving the crash scene.

4.7 Medical Examination

The existence of an injury is judged at the scene of the crash and not by a medical examination after a motor vehicle traffic crash. Transportation from the scene of the crash for medical attention does not, by itself, signify existence of an injury.

4.8 Time of Classification

Injuries should be classified on the basis of conditions observed at the scene of the crash or known at the time the crash report is prepared. However, if information is received establishing that an injury produced death within thirty (30) days of the motor vehicle traffic crash, the severity of injury classification should be changed accordingly.

4.9 Classification of Fatal Injuries

Injuries sustained in a motor vehicle traffic crash may or may not be the direct cause of death. There may have been subsequent illness that contributed directly to the death of the injured person, or the death may have happened so long after the crash that it cannot be considered in current statistical summaries. Thus, time and underlying cause of death must be considered. The following guides are provided for determining underlying cause of death.

- Underlying Cause of Death – This is the cause of death assigned for primary tabulation and analysis purposes. Determine an underlying cause of death from information recorded in the medical certification portion of the death certificate in accordance with the categories in Vital Statistics Instructions for Classifying Underlying Cause of Death, 2014.** Usually, the underlying cause is the disease or external means of injury which initiated the sequence of events leading to death.
- Classification Assistance - Since the underlying cause of death must be determined from the medical certification portion of the death certificate and detailed instructions are required to do this successfully, classifiers of motor vehicle traffic crashes should seek assistance when questionable cases arise. Normally, the medical examiner or coroner will be the final authority on matters pertaining to cause of death.
- Late Effects of Motor Vehicle Crash Injury -If the selected underlying cause of death is a motor vehicle crash that occurred more than thirty (30) days prior to death, the death will not be assigned to that crash and previously released injury statistics should not be adjusted.

4.10 Discharge from Hospital

Discharge from Hospital of a person who has been injured in a motor vehicle traffic crash is not proof of recovery. If the person dies later, assign the death to the condition indicated by the physician to be the underlying cause of death in accordance with the Vital Statistics Instructions for Classifying Underlying Cause of Death, 2014.**

** Vital Statistics Instructions for Classifying Underlying Cause of Death, 2014,

Department of Health and Human Services, Center for Disease Control and Prevention,

National Center for Health Statistics, National Vital Statistics System

http://www.cdc.gov/nchs/nvss/instruction_manuals.htm

5.0 CLASSIFICATION BY LOCATION OF MOTOR VEHICLE TRAFFIC CRASHES

The location classification of motor vehicle traffic crashes applies to junction, class of trafficway, land use character, and political subdivision at, upon, or within which such crashes may occur. The classification is used to assign motor vehicle traffic crashes to political subdivisions, such as counties, and to specified locations, such as trafficways, within these limits.

The classification provides categories by which the location of motor vehicle traffic crashes may be identified and summarized. The categories include:

- Relationship to Junction
 - At intersection
 - Intersection related
 - Driveway access
 - Non-intersection
- Class of Trafficway
 - Interstate system
 - U.S. route – numbered
 - State route – numbered
 - Farm or ranch to market – numbered
 - County roads
 - Local streets
 - All other trafficways
- Land Use Character
 - Urban
 - Rural
- Political Subdivisions
 - County
 - City

6.0 DEFINITIONS AND INTERPRETATIONS FOR LOCATION OF MOTOR VEHICLE TRAFFIC CRASHES

6.1 Classification by Relationship to Junction

Motor vehicle traffic crashes occurring at or between junctions may be categorized as at intersection, intersection related, driveway access, or non-intersection crashes.

- Intersection is an area which contains a crossing or connection of two or more roadways not classified as driveway access and is embraced within the prolongation of the lateral curb lines or, if none, the lateral boundary lines of the roadways. Where the distance along a roadway between two areas meeting these criteria is less than 10 meters (33 feet), the two areas and the roadway connecting them are considered to be parts of a single intersection.
- Junction is either an intersection or the connection between a driveway access and a roadway other than a driveway access.

6.2 Driveway Access

Driveway Access is a roadway providing access to property adjacent to a trafficway.

6.3 At Intersection Crash

At Intersection Crash is a traffic crash in which the first harmful event occurs within the limits of an intersection.

6.4 Intersection Related Crash

Intersection Related Crash is a traffic crash in which the first harmful event both:

- occurs on an approach to or exit from an intersection, and
- results from an activity, behavior or control related to the movement of traffic units through the intersection.

6.5 Driveway Access Crash

Driveway Access Crash is a traffic crash in which the first harmful event occurs on a driveway access or involves a vehicle entering another roadway from a driveway access or entering a driveway access from another roadway.

6.6 Non-intersection Crash

Non-intersection Crash is a traffic crash that is not an intersection crash or intersection-related crash.

6.7 Class of Trafficway

Class of Trafficway is an order of precedence by which motor vehicle traffic crashes may be categorized and assigned to the trafficway location classification. Such crashes are assigned to the highest class, or category, to which the trafficway, or trafficways, on which they occur can be attributed. The classes or categories are in descending order:

- Interstate is any trafficway within the national system for interstate trafficways.
- U.S. Route Numbered is any trafficway within the U.S. trafficway system, excluding interstate.
- State Route Numbered is any trafficway within the State trafficway system, excluding interstate or U.S. route numbered highway.
- County Road is any trafficway within a county trafficway system that does not fall within the interstate, U.S. route numbered, State route numbered, or local street system.
- Local Street is any trafficway within a city trafficway system that does not fall within the interstate, U.S. route numbered, State route numbered, or county road system.
- All Other Trafficways are trafficways which do not meet the specifications for the trafficways of higher precedence such as alleys and private roads open to the public for purposes of vehicular travel.

6.8 Land Use Character

Land Use Character is a classification that provides categories for the assignment of motor vehicle traffic crashes to areas that conform to the concept of incorporated and unincorporated places. For example, motor vehicle traffic crashes are located as rural or urban based upon city limit boundaries.

- Urban Crash is a motor vehicle crash that occurs at a location within the limits of a city having 5,000 or more population.
- Rural Crash is a motor vehicle crash that cannot be classified as an urban crash.

6.9 Highway Engineering Terms

The following definitions are included for clarification of words and phrases used in this section:

- Ramp is an interconnecting roadway of a traffic interchange, or any connection between highways at different levels or between parallel highways, on which vehicles may enter or leave a designated roadway.
- At-Grade Intersection is an intersection, or junction, where all roadways cross or join at the same level.
- Unchannelized At-Grade Intersection is an at-grade intersection, or junction, without islands for directing traffic into definite paths.
- Channelized Intersection is an at-grade intersection in which traffic is diverted into definite paths by raised or painted traffic islands.
- Grade Separation is a crossing at different levels of two trafficways, or trafficway and railway.
- Interchange is a system of interconnecting roadways in conjunction with one or more grade separations, providing for the movement of traffic between two or more roadways on different levels.
- Frontage Road is a roadway generally paralleling an expressway, freeway, parkway, or through street so designed as to intercept, collect and distribute traffic desiring to cross, enter, or leave such facility and to furnish access to property which otherwise would be isolated as a result of the controlled- access features. The frontage road may be within the same trafficway as the main roadway or in a separate trafficway.
- Collector-Distributor Road is an auxiliary roadway, separated laterally from and parallel to a through roadway, which serves to collect and distribute traffic from several access connections between selected points of ingress and egress from the through-traffic lanes.
- Crosswalk:
 - That part of a roadway at an intersection included within the connections of the lateral lines of the sidewalks on opposite sides of the roadway measured from the curbs or, in the absence of curbs, from the edges of the traversable roadway.
 - Any portion of a roadway at an intersection or elsewhere distinctly indicated as a pedestrian crossing by lines or other markings on the surface of the roadway.

6.10 Assignment by Class of Trafficway

Motor vehicle traffic crashes shall be assigned to the highest class in which the trafficway(s) on which they occur belongs, as listed in 3.3. The following assignment guidelines shall be applied.

- At an Intersection: A motor vehicle traffic crash which occurs at a joining or crossing of two or more trafficways shall be assigned to the highest trafficway class of the trafficways which join or cross.
- At a Grade Separation: A motor vehicle traffic crash which occurs at a trafficway grade separation without ramp connections between the trafficways shall be assigned to the trafficway class of the trafficway on which it occurs, without regard to the final position of motor vehicles, occupants, or pedestrians involved.
- On a Ramp: A motor vehicle traffic crash which occurs on a ramp connecting two trafficways shall be assigned to the highest trafficway class of the trafficways involved.
- On a Frontage Road: A motor vehicle traffic crash which occurs on a frontage road shall be assigned to the highest trafficway class of which it is a part, or to the trafficway which it serves.

6.11 Assignment by Political Subdivision

Assign all motor vehicle traffic crashes occurring within the political subdivision of a locality such as a county or city, to that locality regardless of the class of trafficway that may be involved.

6.12 Jurisdiction

Assign each motor vehicle traffic crash to the county or city within which the crash occurred, regardless of the maintenance or police jurisdiction over the trafficway upon which the crash occurred. However, this assignment does not preclude a classification breakdown of such crashes into categories to indicate jurisdiction over the trafficways on which they occur.

6.13 Place of Injury or Damage

Assign the motor vehicle traffic crash to the locality within which the first injury or damage-producing event in the crash occurred. For example, a speeding car loses control and runs off a highway which is contiguous to, but outside the boundaries of a city. The automobile careens into the city and strikes a tree. This crash would be assigned to the city because the first harmful event occurred within the city. Any and all injuries and fatalities resulting from such a crash also would be included in the city's traffic records and statistics. Location of the crash should be identified in reference to the highway from which the vehicle departed, and at that point on the highway that is nearest to the damage or injury producing event.

6.14 Boundary Lines

If the motor vehicle traffic crash occurs exactly on a boundary line between two geographic limits or jurisdictions, the matter should be referred to the Traffic Operations Division - CDA, Texas Department of Transportation, for final decision. In most cases, the crash will be assigned to the area from which the vehicle was headed. For example, if the vehicle was leaving County A going to County B and has a crash exactly on the county line, the crash would be assigned to County A. The same example would apply when a city limit is involved.

6.15 Diagram of the Trafficway*

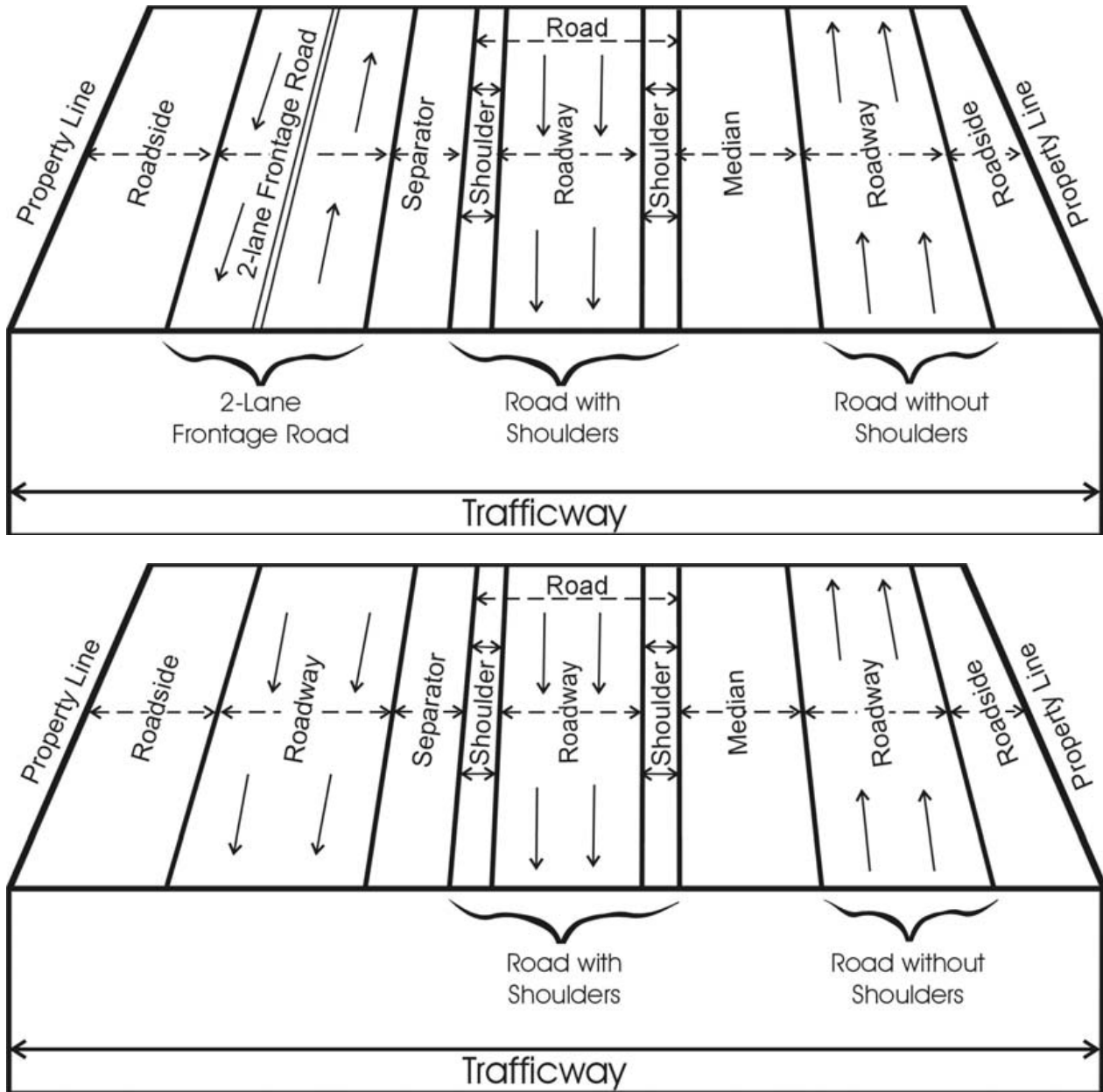

*Source: ANSI D16.1 – 2007 Manual on Classification of Motor Vehicle Traffic Accidents, 7th Edition

6.16 Diagram of an Intersection*

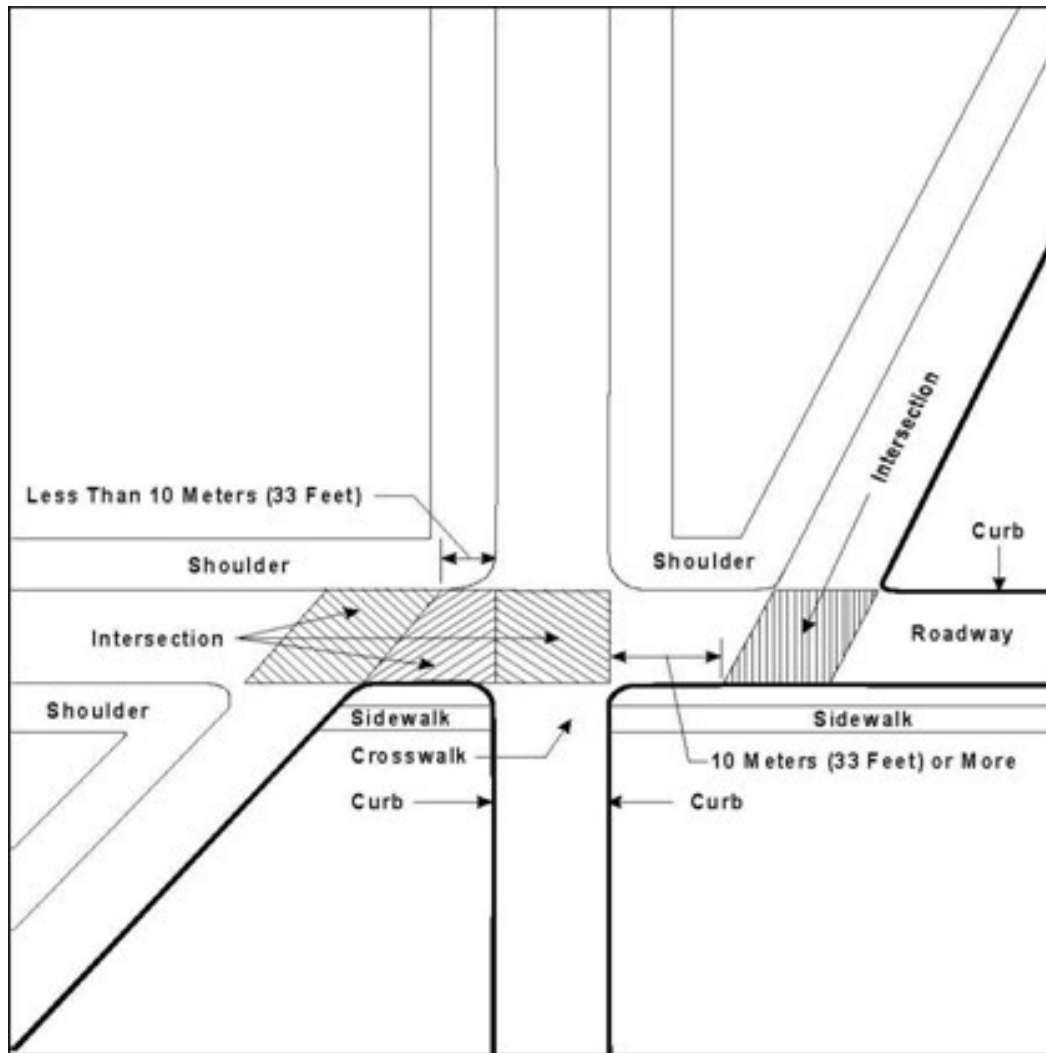

*Source: ANSI D16.1 – 2007 Manual on Classification of Motor Vehicle Traffic Accidents, 7th Edition

6.17 Diagram of an Interchange*

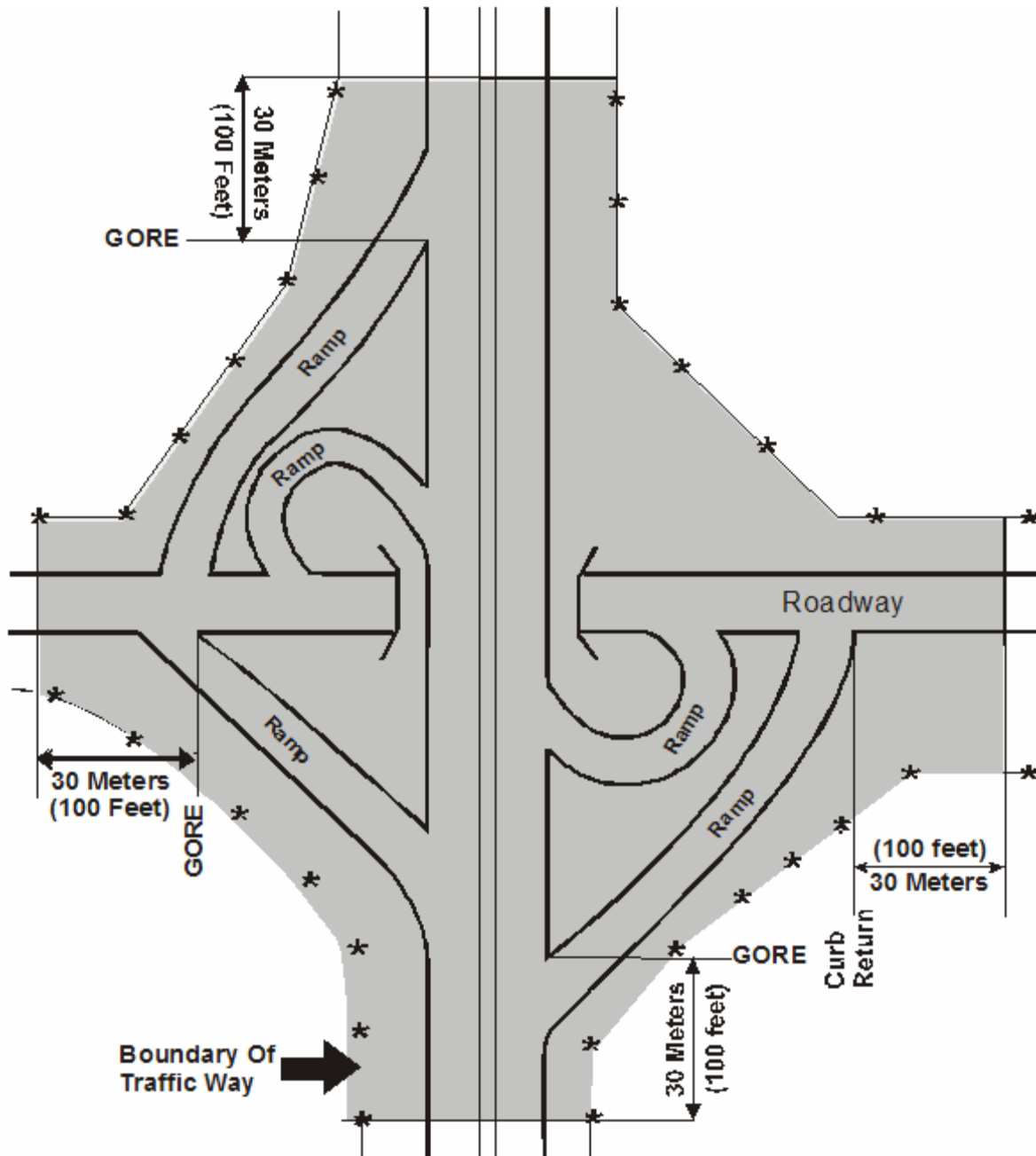

*Source: ANSI D16.1 – 2007 Manual on Classification of Motor Vehicle Traffic Accidents, 7th Edition

7.0 CLASSIFICATION BY TYPE OF MOTOR VEHICLE TRAFFIC CRASHES

The type classification, also called First Harmful Event, for motor vehicle traffic crashes applies to the nature of the crash and the location of the motor vehicle in relation to the roadway at the time of the first injury or damage-producing event. This classification establishes categories to describe the nature of the crash. For this purpose, the entire crash is categorized according to what happened in the crash in reference to the roadway; that is, on or off the roadway. The classification provides categories to segregate motor vehicle traffic crashes by types. Two broad injury and damage producing events, collision and non-collision, have ten mutually exclusive categories describing the nature of crashes that may occur on or off the roadway. They are:

- Non-collision involving a motor vehicle in transport:
 - Overturning
 - Other non-collision
- Collision between a motor vehicle in transport and:
 - Pedestrian
 - Motor vehicle in transport
 - Parked motor vehicle
 - Railway train
 - Pedalcyclist
 - Animal
 - Fixed object
 - Other object

Every motor vehicle traffic crash consists of a series of events. In classification by type, one of these events must be selected before further classification can be made. This event must be one which can be easily determined by whoever classifies the crash report from information about what occurred in the crash. For uniformity in classification, the event to be selected is the first injury or damage producing event that can be determined to have happened in the crash, such as overturning, catching on fire, or collision. The ten categories describing the nature of the crash are applicable to both on and off roadway crashes.

8.0 DEFINITIONS AND INTERPRETATIONS OF TYPE OF MOTOR VEHICLE TRAFFIC CRASHES

8.1 Motor Vehicle Crash

Is any crash involving a motor vehicle in transport that involves an occurrence of injury or damage as defined in 4.1 and 1.17.

8.2 Non-collision Crash

Is any crash involving a motor vehicle in transport, which may occur in any manner other than by collision. There are two types of non-collision crashes: overturning and other non-collision.

- Overturning Crash is any crash in which a motor vehicle in transport overturns for any reason without antecedent crash.
- Other Non-collision Crash is any crash involving a motor vehicle in transport, other than overturning and collision.
 - Includes:
 - Accidental poisoning from carbon monoxide generated by a motor vehicle in transport.
 - Breakage of any part of the motor vehicle, resulting in injury or in further property damage.
 - Explosion of any part of the motor vehicle.
 - Fire starting in the motor vehicle.
 - Occupant falling, jumping, or being pushed from the motor vehicle.
 - Injury or damage from moving part of the motor vehicle.
 - Object falling from, or in, the motor vehicle.
 - Object thrown towards, in, or on the motor vehicle.
 - Object falling on the motor vehicle.
 - Toxic or corrosive chemicals leaking out of the motor vehicle.
 - Injury or damage involving only the motor vehicle that is of the non- collision nature, such as a bridge giving way under the weight of a motor vehicle, striking holes or bumps on the surface of the trafficway, or driving into water, without overturning or collision.
 - Other injury or damage which originates upon or in the motor vehicle, excluding events not a hazard of transport, such as a fight between occupants, occupant injured by a burning cigarette, or similar event.
 - Excludes:

- Carbon monoxide poisoning in a motor vehicle not in transport.
- Breakage of any part, such as fan belt or axle, if there is no additional damage or injury.
- Injury or damage resulting from discharge of a firearm in the motor vehicle.
- Injury or damage resulting from working on a motor vehicle not in transport.

8.3 Collision Crash

Is any crash involving a motor vehicle in transport, in which the motor vehicle, its load, its parts, or objects set in motion by the motor vehicle, collides with other things, such as other motor vehicles, railway trains, pedestrians, animals, or objects fixed, movable or moving.

Types of collision crashes include:

- Collision Involving Pedestrian is any crash involving a motor vehicle in transport and a pedestrian.
 - Includes: a person afoot, sitting, lying, or working upon a way or place.
 - Excludes: a person boarding or alighting from another conveyance and a person in the process of jumping or falling from a motor vehicle in transport.
- Collision Involving Motor Vehicle in Transport is any crash involving at least two motor vehicles in transport.
 - Includes: a collision with a motor vehicle stopped, disabled, or abandoned on a roadway other than an area designated for parking.
- Collision Involving Parked Motor Vehicles is any crash involving a motor vehicle in transport and a motor vehicle not in transport. A parked motor vehicle is a motor vehicle not in-transport, other than a working motor vehicle, that is not in motion and not located on the roadway. In roadway lanes used for travel during some periods and for parking during other periods, a parked motor vehicle should be considered to be in-transport during periods when parking is forbidden.
 - Includes:
 - Motor vehicle parked in a place designated for parking, even though the permitted time period may have expired.
 - Motor vehicle stopped or parked along the roadway where normal usage permits such stopping or parking, including parking adjacent to curbs and parking on trafficway shoulders.

- Motor vehicle stopped or parked illegally, but otherwise outside the roadway traffic lanes, such as blocking driveway, beside fire hydrant, or in loading zone.
- Motor vehicle stopped, disabled, or abandoned off roadway. Load in the process of falling from parked motor vehicle.
- Any stopped motor vehicle where the entirety of the vehicle's primary outline as defined by the four sides of the vehicle (e.g., tires, bumpers, fenders) and load, if any, is not within the roadway.
- Examples:
 - A driver of vehicle stopped curbside on a city street opens his door into the travel lane.
 - A truck stopped on the shoulder where only the extended side-view mirror overhangs the roadway edge line.
 - A motionless vehicle on the shoulder, median, or roadside.
 - A truck stopped at a gas station pump.
 - A car stopped in a private driveway.
 - A van parked in a metered parking lane, even when the meter time has expired.
- Excludes:
 - Motor vehicle stopped or parked in traffic lanes where parking is always prohibited, such as double parked, on the side of the street where there is not parking at any time along the length of the street, in tunnels or on bridges where parking is prohibited, or in a parking lane during the hours that it is required to be clear for traffic.
 - Stopped or parked self-propelled machinery even though such machinery is considered a motor vehicle when in transport.
 - Load that has fallen from a parked motor vehicle.
 - Motor vehicle in motion anywhere within the trafficway boundaries or any vehicle that has any portion of its primary outline or load, if any, overlapping or falling completely within the roadway.
- Examples:
 - A vehicle driving down the road shoulder, median, or roadside. ANSI D16.1 – 2007 Manual on Classification of Motor Vehicle Traffic Accidents, 7th Edition.
 - A driverless motor vehicle without engine power starts in motion from a stopped position on the shoulder.
 - A stopped vehicle partially on the shoulder with two tires on the roadway.

- A tractor trailer with part of its load extending over the roadway edge line.
 - A van left unattended in a lane during rush hour when parking is prohibited because it is an open travel lane at that time.
 - A delivery service leaves his truck stopped at the curb of a street marked with “no parking at any time” signs while making his delivery.
- Collision Involving Railway Train is any crash involving a motor vehicle in transport and a railway train or railway vehicle (see 1.8).
 - Includes:
 - Railway train, with or without cars.
 - Motorized railway device.
 - Railway device, such as cars, set in motion by a railway train or railway vehicle.
 - Excludes:
 - Devices operated upon railway by human power.
 - Non-motorized devices not set in motion by a railway train or railway vehicle.
 - Collisions in which a railway train was involved in a railway transport crash prior to involvement with the motor vehicle, such as derailment, or throwing some part, animal, or pedestrian against a motor vehicle.
 - General:
 - Motion of the motor vehicle is immaterial; it can be in motion or stopped in the path of the railway train.
 - Motion of the railway train is immaterial; it can be stopped in the path of the motor vehicle or in motion.
 - Whether the motor vehicle or the railway train does the actual striking is immaterial.
- Collision Involving Pedalcyclist is any crash involving a motor vehicle in transport and a pedalcyclist in transport.
 - Includes any of the following devices in transport:
 - Bicycle
 - Tricycle
 - Unicycle
 - Trailers or sidecars attached to any of above devices
 - Pedalcar (PPV)
 - Excludes:

- Pedalcycle towed by motor vehicle, including hitching and unoccupied pedalcycle.
- General:
 - A pedalcyclist is any person riding upon a pedalcycle or in a sidecar attached to the pedalcycle.
 - A stopped pedalcycle is considered to be in transport if attended (pedalcyclist need not be occupying the riding saddle) and in readiness for transport, such as stopped at a stop sign, traffic light, or waiting in traffic for any reason, but not pushing the pedalcycle.
 - A coasting pedalcyclist with rider is in transport.
 - If the motor vehicle and pedalcycle are in transport, which one does the actual striking is immaterial.
- Collision Involving Animal is any crash involving a motor vehicle in transport and an animal.
 - Includes:
 - domestic and wild animals, and flying animals, such as birds and bats.
 - Excludes:
 - ridden animals, animal drawing a conveyance.
 - General:
 - Injury to wild animals, such as birds and rabbits, is excluded.
 - Injury to domestic animals is treated as property damage.
- Collision Involving Fixed Object is any crash involving a motor vehicle in transport and a fixed object.
 - Includes:
 - Any object attached to the terrain.
 - Tree, boulder, utility pole, traffic signals, guardrail, bridge abutment or similar object.
 - Any object intentionally placed for an official purpose; traffic barricades, road machinery, construction machinery, construction materials, or similar objects placed on or along the roadway for some purpose.
 - Excludes any object in motion.
- Collision Involving Other Object is any crash involving a motor vehicle in transport and any other object, which is moveable or moving, but not fixed.
 - Includes:

- Animal-drawn vehicle (any type).
- Animal carrying a person.
- Streetcar.
- Objects dropped from motor vehicle or other vehicles but not in motion.
- Special devices not considered in transport or as fixed objects.
- Fallen tree or stone.
- Landslide or avalanche materials, not in motion.
- Pedalcycle not in transport.
- Railway devices moved by human power.
- Non-motorized devices not set in motion by railway train or railway vehicle.
- Excludes:
 - Objects set in motion by aircraft, watercraft, railway, or other motor vehicle.
 - Objects set in motion by cataclysm, lightning, or other natural and environmental factors.

8.4 Interpretations

- Location of the Event or Motor Vehicle
 - The nature of the injury- or damage-producing event affects the location classification of the motor vehicle traffic crash that is on or off the roadway. The distinction is made when non-collision and collision crashes are considered. First, the location of the motor vehicle is considered; second, the location of the crash is considered.
- Non-collision Crash
 - In a non-collision crash, the location of the motor vehicle at the time of the crash determines whether the crash occurred on or off the roadway. If, at the time of the crash, the motor vehicle occupied any portion of the roadway, the crash shall be considered to have occurred on the roadway (see 8.5 Figure 1).
- Collision Crash
 - In a collision crash, the on and off roadway classification is determined by the location of the crash, or the point of impact, in relation to the boundaries of the roadway. If the crash is established as having been within the boundaries of the roadway, the crash shall be considered to have occurred on the roadway. If the crash is established as having been outside the boundaries of the roadway, the crash shall be considered to have occurred off the roadway, even though the motor vehicle may occupy a part of the roadway (see 8.6 Figure 2).
- When More Than One Event Occurs

- A motor vehicle traffic crash in which there is more than one injury or damage-producing event should be classified by type according to the location and nature of the first event to occur, considering the distinctions made in 8.4 on location of the event or motor vehicle.

Examples are:

- Two motor vehicles in transport collide on the roadway, then one motor vehicle runs onto the sidewalk and injures a pedestrian. Classify the entire crash as “on roadway – collision involving motor vehicle in transport”.
- Two motor vehicles in transport bump together, but there is no injury or damage, but one motor vehicle runs onto the sidewalk and injures a pedestrian. Classify the crash as “off roadway – collision involving pedestrian.”
- A motor vehicle in transport leaves the roadway, strikes and damages a sign, then returns to the roadway and collides with a motor vehicle in transport. Classify the entire crash as “off roadway – collision involving fixed object” (see 8.7 Figures 1, 2, and 3).
- Pedalcyclist and Pedestrian Types of Motor Vehicle Traffic Crashes
 - Crash reports can provide useful information on the involvement of persons in crashes who are not occupants of motor vehicles or riding animals. Involved persons may be divided into three categories and their severity of injury established by using the categories of injury listed in Section 3.0.
 - The three categories are:
 - Persons occupying a pedalcycle or a sidecar attached to a pedalcycle.
 - Persons afoot, including walking, sitting, lying, or working upon a land way or place.
 - Persons in or operating a pedestrian conveyance.
 - Summarization of crash and injury experience on this basis could be helpful in developing remedial measures dealing with crashes involving pedalcyclists and pedestrians.

8.5 Diagrams of Non-Collision Events, On or Off Roadway

Figure 1: On Roadway – Other Non-Collision

Motor Vehicle on roadway catches on fire, occupant is injured, motor vehicle goes out of control, leaves the roadway, and overturns.

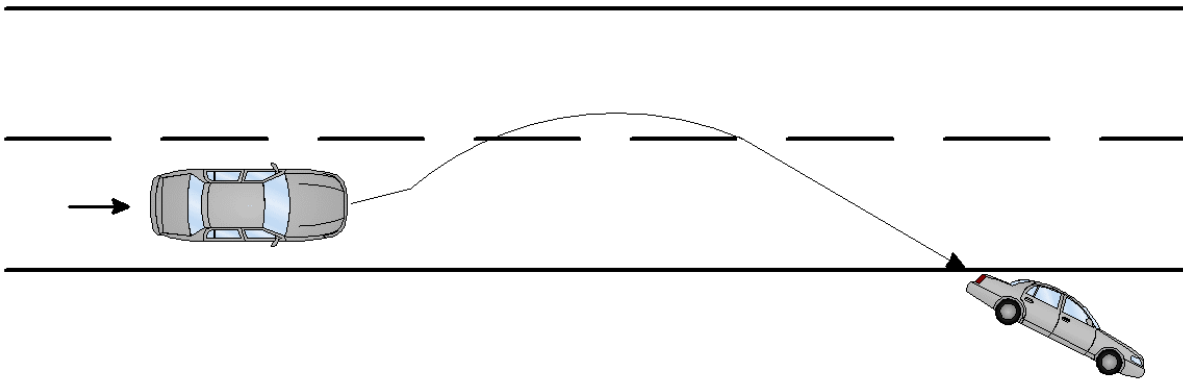

Figure 2: On Roadway – Other Non-Collision

Motor Vehicle on roadway goes out of control, an occupant jumps out while motor vehicle occupies a portion of the roadway, occupant is injured in the jump, and motor vehicle leaves the roadway and overturns.

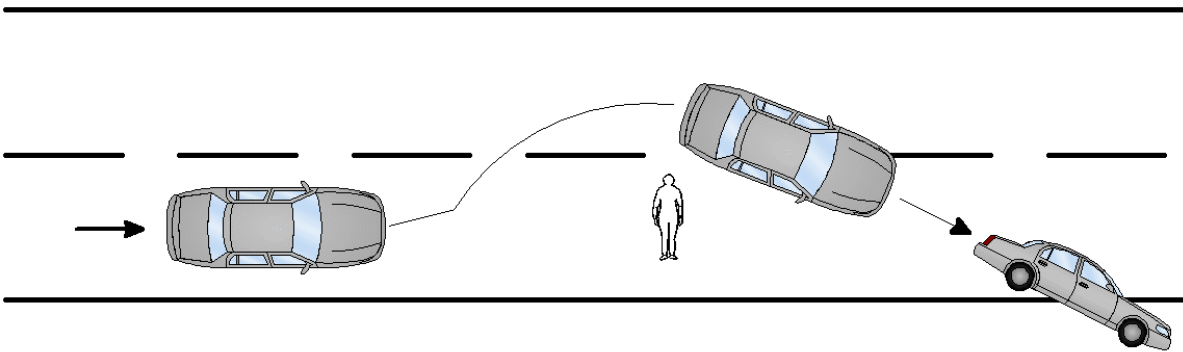

Figure 3: On Roadway – Other Non-Collision

Motor Vehicle on roadway strikes pavement defect, occupant is thrown inside motor vehicle and is injured, motor vehicle goes out of control, leaves roadway, and overturns.

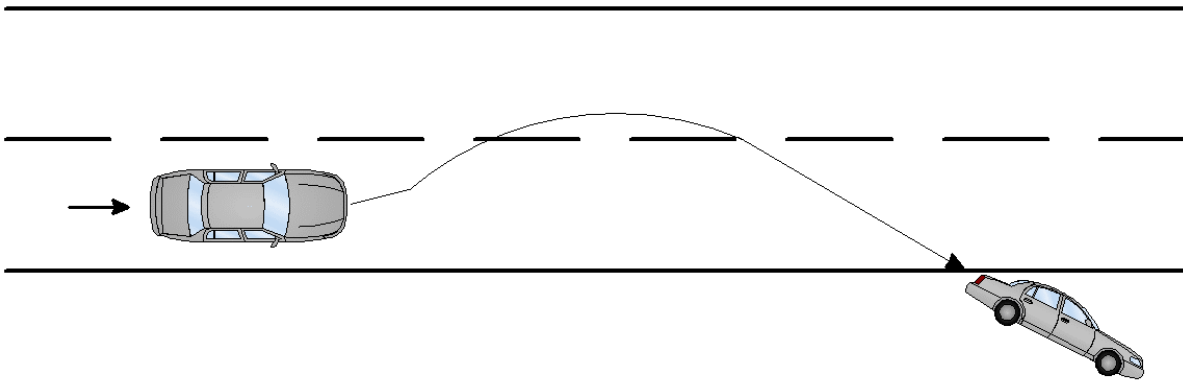

Figure 4: Off Roadway – Overturning

Motor Vehicle on roadway strikes pavement defect, there is no injury or damage, motor vehicle goes out of control, leaves roadway, and overturns, injuring occupants.

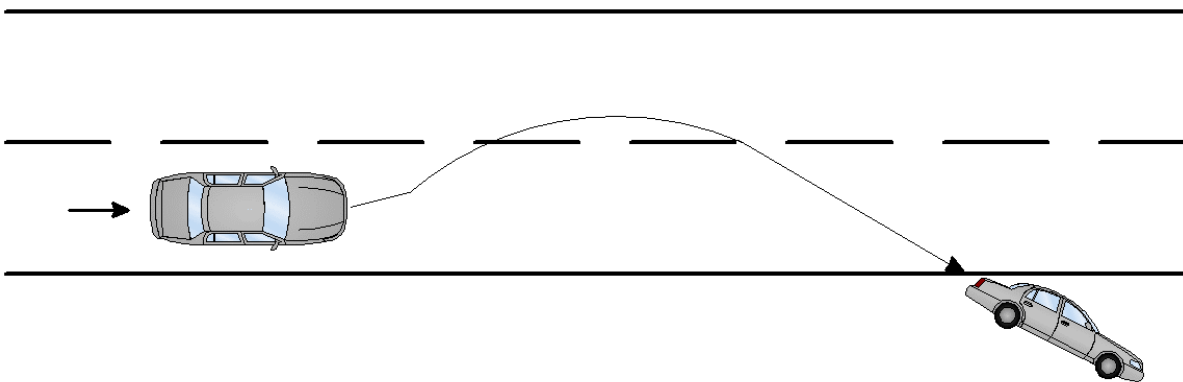
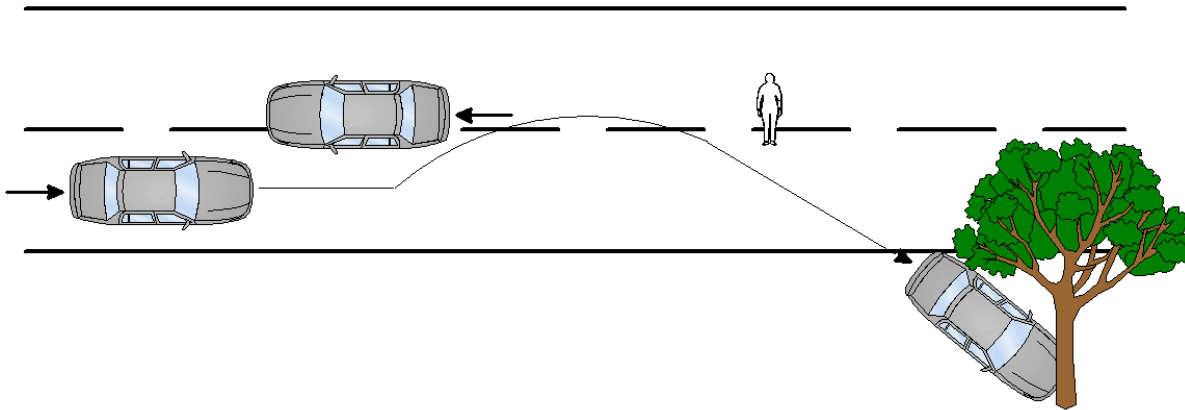

Figure 5: Off Roadway – Other Non-Collision

Motor Vehicle on roadway avoids other motor vehicle, goes into skid, wheels catch on edge of pavement. Occupant falls out and is injured after the motor vehicle leaves the roadway, and the motor vehicle runs into a tree.



8.6 Diagrams of Collision Events, On or Off Roadway

Figure 1: On Roadway – Collision Involving Motor Vehicle

Motor vehicle on roadway collides with other motor vehicle on roadway, resulting in injury and damage.

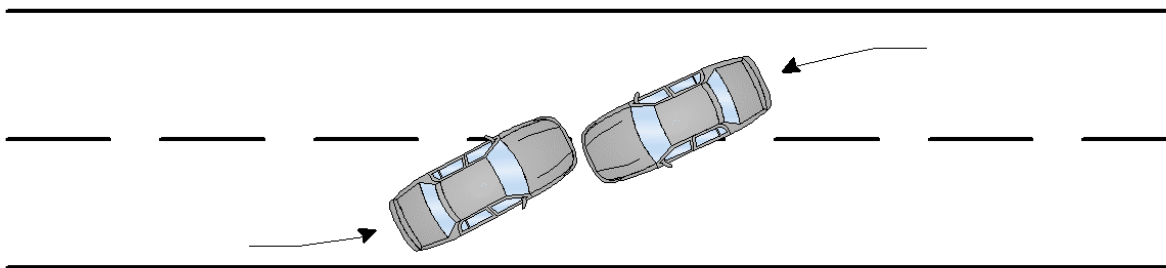

Figure 2: Off Roadway – Collision Involving Fixed Object

Motor vehicle partially on roadway collides with a tree off the roadway, damaging the motor vehicle and injuring occupants.

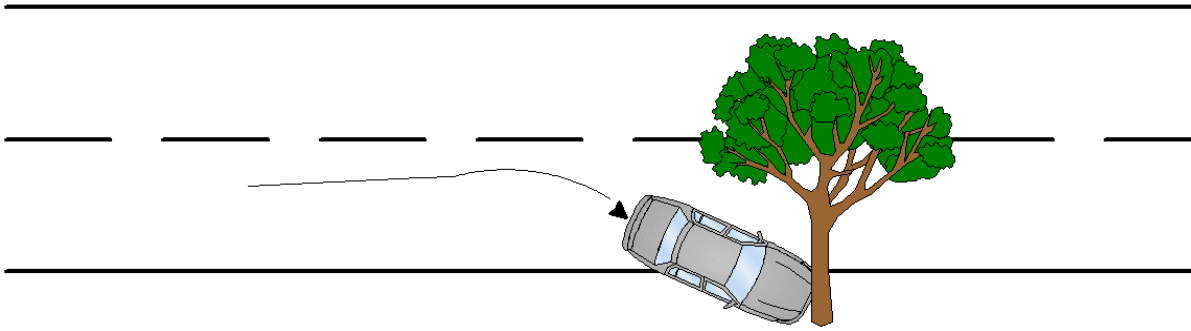

Figure 3: Off Roadway – Collision Involving Parked Motor Vehicle

Motor vehicle on roadway veers partially off roadway and collides with a parked motor vehicle off roadway, injuring occupants and damaging motor vehicles.

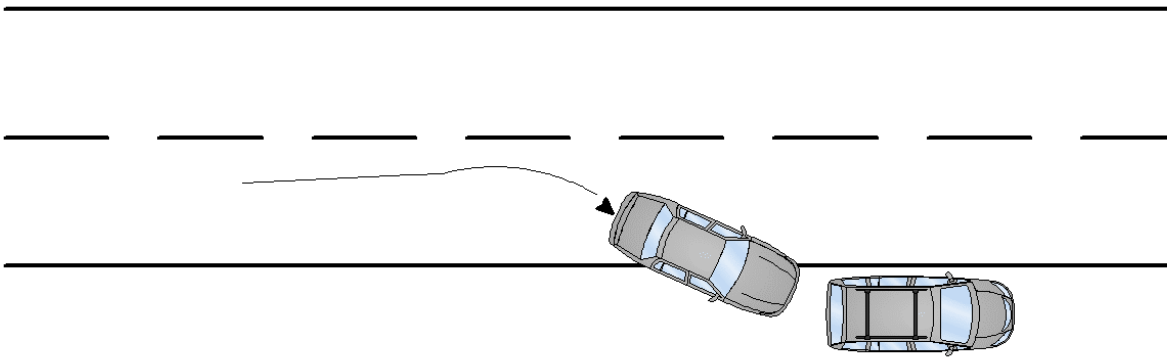

Figure 4: On Roadway – Collision Involving Fixed Object

Motor vehicle (over height truck) on roadway drives under an overpass and the top of the truck strikes the overpass, damaging the motor vehicle.

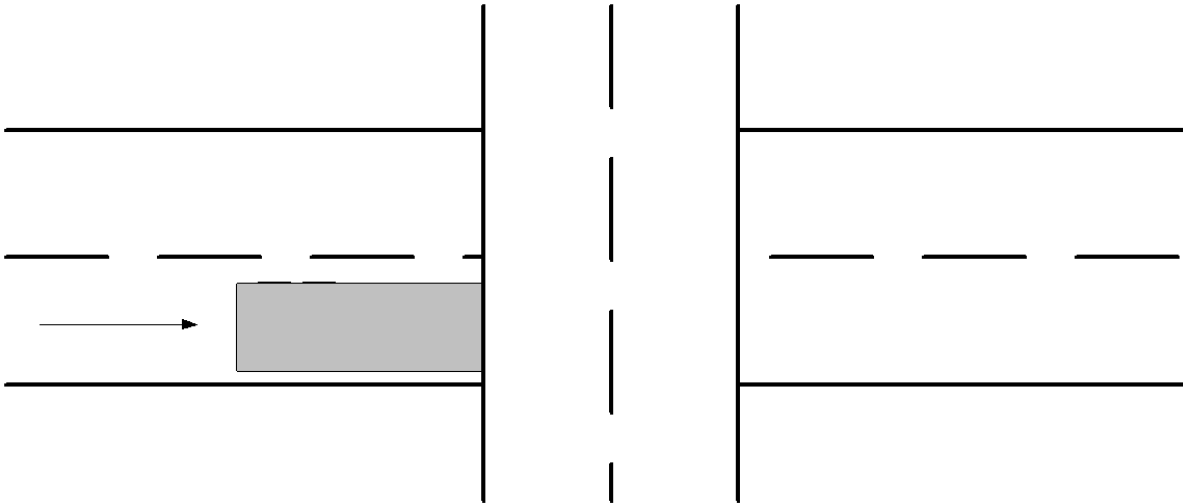
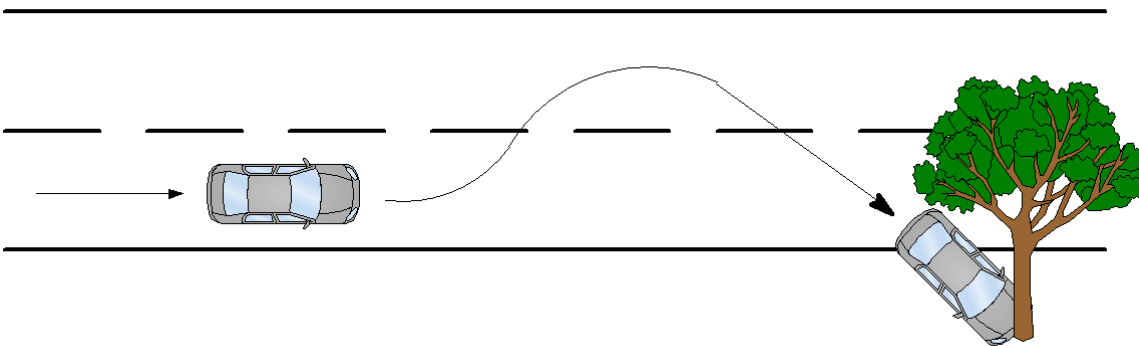

Figure 5: Off Roadway – Collision Involving Fixed Object

Motor vehicle on roadway goes out of control, skids, runs off the roadway, collides with a tree, injuring occupants and damaging motor vehicle.



8.7 Diagrams of When More Than One Event Occurs

Figure 1: On Roadway – Collision Involving Motor Vehicle

Two motor vehicles collide on roadway, motor vehicles are damaged, one motor vehicle leaves roadway, runs onto sidewalk, and injures a pedestrian.

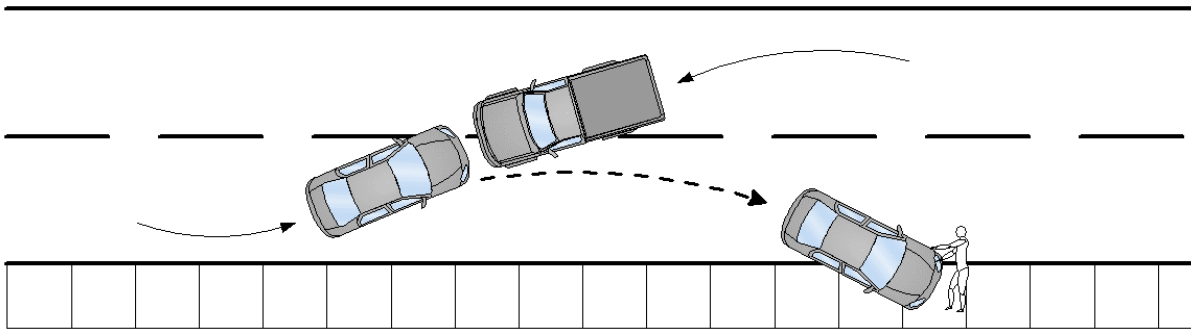

Figure 2: Off Roadway – Collision Involving Pedestrian

Two motor vehicles on roadway bump, there is no injury or damage, one motor vehicle leaves the roadway, runs onto sidewalk, and injures a pedestrian.

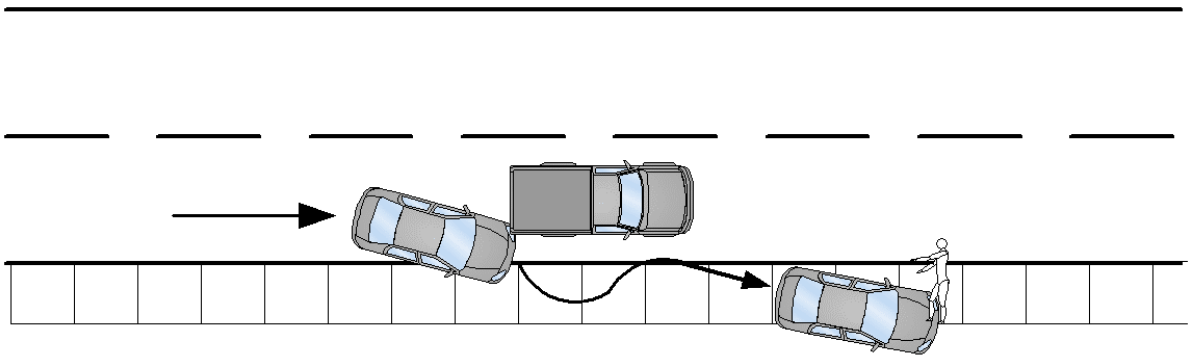

Figure 3: Off Roadway – Collision Involving Fixed Object

Motor vehicle on roadway leaves roadway, knocks down a breakaway traffic sign, damaging motor vehicle and sign, returns to roadway, collides with motor vehicle on roadway, injuring occupants and damaging motor vehicles.

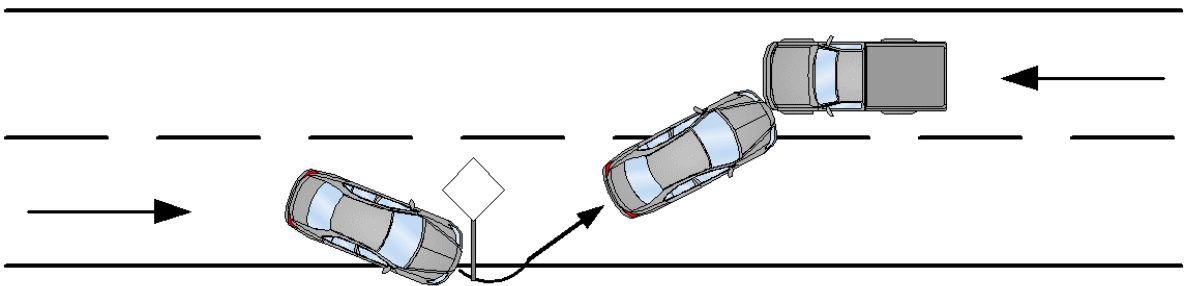
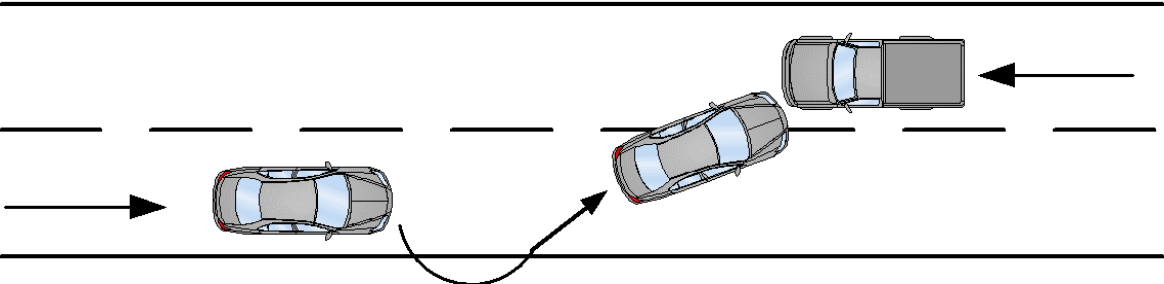

Figure 4: On Roadway – Collision Involving Motor Vehicle

Motor vehicle on roadway runs off roadway, there is no injury or damage, motor vehicle returns to roadway and collides with another motor vehicle on roadway, injuring occupants and damaging motor vehicles.



9.0 CLASSIFICATION OF MOTOR VEHICLE NON-TRAFFIC CRASHES

Motor vehicle non-traffic crashes may be classified according to the classification categories established for motor vehicle traffic crashes. However, suitable adaptations must be made that are applicable to the off-trafficway character of such crashes.

Since motor vehicle, non-traffic crashes do not occur on trafficways, on roadway and off roadway classifications do not apply. Such crashes occur entirely in any place other than a trafficway. The crash will be classified by categories entirely by the first injury or damage-producing event to occur in the crash. Severity of the crash, location of the crash and types of crashes are identical to motor vehicle traffic crashes.

IF YOU HAVE ANY QUESTIONS OR NEED FURTHER CLARIFICATION

Contact information:
(844) CRIS-HLP, (844-274-7457)
support@crishlp.com

Mail crash reports to:
Texas Department of Transportation
Traffic Operations Division - CDA
PO Box 149349
Austin, TX 78714-9349

To obtain crash forms go to:
<http://www.txdot.gov/inside-txdot/forms-publications/drivers-vehicles/forms/crash-records.html>

To obtain Crash Data Analysis and Statistical Data:
<http://www.txdot.gov/inside-txdot/division/traffic/crash-statistics.html>